

DIAMOND

Fiber Optic Components

CABLE ASSEMBLIES AND ADAPTERS

Thanks to its different technologies, mechanical and optical interfaces, the F-3000™ fiber optic connector family can cover the most standard and customized requirements in response to the increasingly customer demands. The family includes: simplex, duplex and backplane connectors and adapters, as well as a series of network accessories such as: attenuators, hybrid adapters, transition adapters, terminators, reflectors and receptacles.

FEATURES AND BENEFITS INCLUDE

- ▶ Spring-loaded protective cap for high power applications providing increased safety protection
- ▶ Specially designed body to prevent endface damage during mating
- ▶ Modular designed mating adapters with metal protective shutters for high power applications
- ▶ Diamond composite ferrule (zirconia ceramic sleeve and titanium insert):
 - Allows plastic deformation for our Active Core Alignment (A.C.A)
 - Unique 0.1 dB Insertion Loss
 - Custom drill sizes from 80µm to 280µm
 - Superior Ultra polishing
 - Custom ferrules for multi-fiber technology
 - Ultra-low ferrule O.D. tolerances



AVAILABLE TECHNOLOGIES AND OPTICAL INTERFACES

- ▶ PS optical interfaces: PS collimated, PSf free space, PM-PS, PSi Free standing, PSm Multimode, PSc collimator.
- ▶ Polarization Maintaining (PM)
- ▶ VIS/NIR for low wavelengths and small core fibers
- ▶ Optical Line Identification OLID assemblies
- ▶ F-3000™ FUSION for easy field termination of MM and SM fibers

F-3000™ Family

SINGLE MODE PC/APC
MULTIMODE PC
PS, PSf, PM-PS, PSi, PSm, PSc, PM,
VIS/NIR

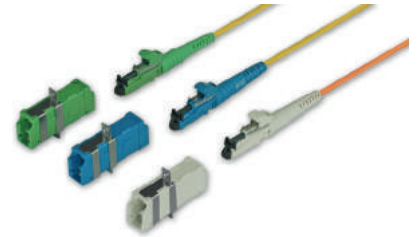

F-3000™ Simplex

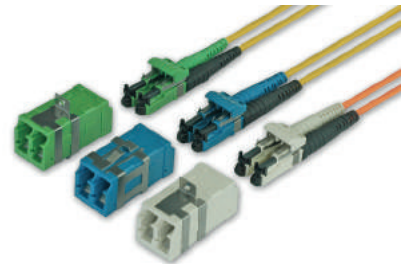

F-3000™ Duplex



F-3000™ Backplane 2-4 channels



F-3000™ Power Solution (PS)

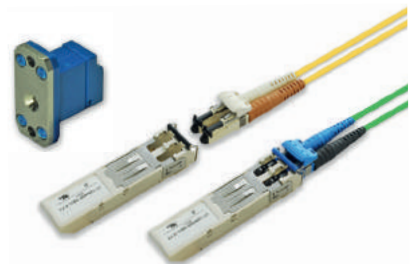

F-3000™ Accessories and transceivers



DIAMOND SA | Via dei Patrizi 5 | CH-6616 Losone - Switzerland
Tel. +41 58 307 45 45 | e-mail info@diamond-fo.com

www.diamond-fo.com

Specifications subject to change without notice

BDD 1951622_01_18

THE F-3000™ SIMPLEX

The F-3000™ is a small form factor SFF fiber optic connector based onto 1.25 mm ferrule style. It has been recently standardized as LF3 connector, thus clarifying and ensuring the mechanical compatibility of the F-3000™ connector with the LC adapter. This opens access to a broad field of existing applications, and will be increased with new customer specific solutions.

STANDARDS

- ▶ IEC 61 754-28 “Fiber optic interconnecting devices and passive components - Type LF3 connector family”
EN 50377-16-1 Product specification: Part 16-1: Type LF3 APC simplex terminated on IEC 60793-2-50 category B1.1 and B1.3 single mode fibre with titanium composite ferrule for Category C
The LF3 connector is compatible with all IEC 61 754-20 compliant adapters

AVAILABLE AS

- ▶ Standard terminated connector, also for applications up to 3W
- ▶ Connector set (to be terminated with Diamond special equipment)

OPTICAL SPECIFICATIONS

STANDARD	MULTIMODE 0° PC	SINGLE MODE 0° PC	SINGLE MODE 8° APC	UNITS	TEST CONDITIONS
Insertion Loss (IL)	typ. 0.15 max. 0.4	typ. 0.1 max. 0.4	typ 0.1 max. 0.4	dB	IEC 61300-3-4; λ = 1300/1550nm
Return Loss (RL)	typ. 40	min. 50	min. 70*	dB	IEC 61300-3-6; λ = 1300/1550nm
Repeatability of IL	max. ±0.1			dB	IEC 61300-2-2; λ = 1300/1550nm
LOW IL VERSION		SINGLE MODE 0° PC	SINGLE MODE 8° APC		
Insertion Loss (IL)	-	typ. < 0.1 max. 0.15	typ. < 0.1 max. 0.15	dB	IEC 61300-3-4; λ = 1300/1550nm
Return Loss (RL)	-	min. 50	min. 85*	dB	IEC 61300-3-6; λ = 1300/1550nm
Storage temperature	-40/+90**			°C	

* Measured with high precision reflectometer

ENVIRONMENTAL CONDITIONS

MEASUREMENT / TEST	PARAMETERS	METHOD
Change of temperature (Reliability)	-40°C / +85°C / 1 h dwell / 500 cycles	IEC 61300-2-22
Low temperature	-51°C / 96 h	MIL-STD-810F
Dry heat (Reliability)	+85°C / 2'000 h	IEC 61300-2-18
Thermal shock	-51°C / +71°C / 1 h dwell / 3 cycles	MIL-STD-810
Low pressure, procedure II	4'572 m / 1 h	MIL-STD-810
Low pressure, procedure III	2'438 m to 12'192 m / 60 s	MIL-STD-810
Damp heat, cyclic (Reliability)	+25°C / +55°C / 95% r.h. / 100 cycles	IEC 61300-2-46
Extended humidity (Reliability)	+85°C / 85% rh / 2'000 h	Telcordia GR-326-CORE
Salt mist	+35°C / 50 g/l / 96 h	IEC 61300-2-26

MECHANICAL CONDITIONS

Tensile strength of coupling mechanism	40 N / 2 min	IEC 61300-2-6
Cable retention	100 N / 2 min	IEC 61300-2-4
Static side load	1 N / 1 h on cable version 0.2 N / 5 min on fibre version	IEC 61300-2-42
Cable torsion	15 N / ±180° / 25 cycles	IEC 61300-2-5
Twist	1.35 Kg / ±1'800° / 10 cycles	Telcordia GR-326-CORE
Vibration, sinusoidal	10 Hz - 55 Hz / 1.5 mm / 30 min	IEC 61300-2-1
Impact (free fall)	1.5 m / 5 drops	IEC 61300-2-12
Bending moment	10 N / 2 min	IEC 61300-2-7
Mating durability (Couplings)	500 cycles	IEC 61300-2-2
Flexing of strain relief	2 N / +/-90° / 100 cycles	IEC 61300-2-44

F-3000™ Simplex standard version

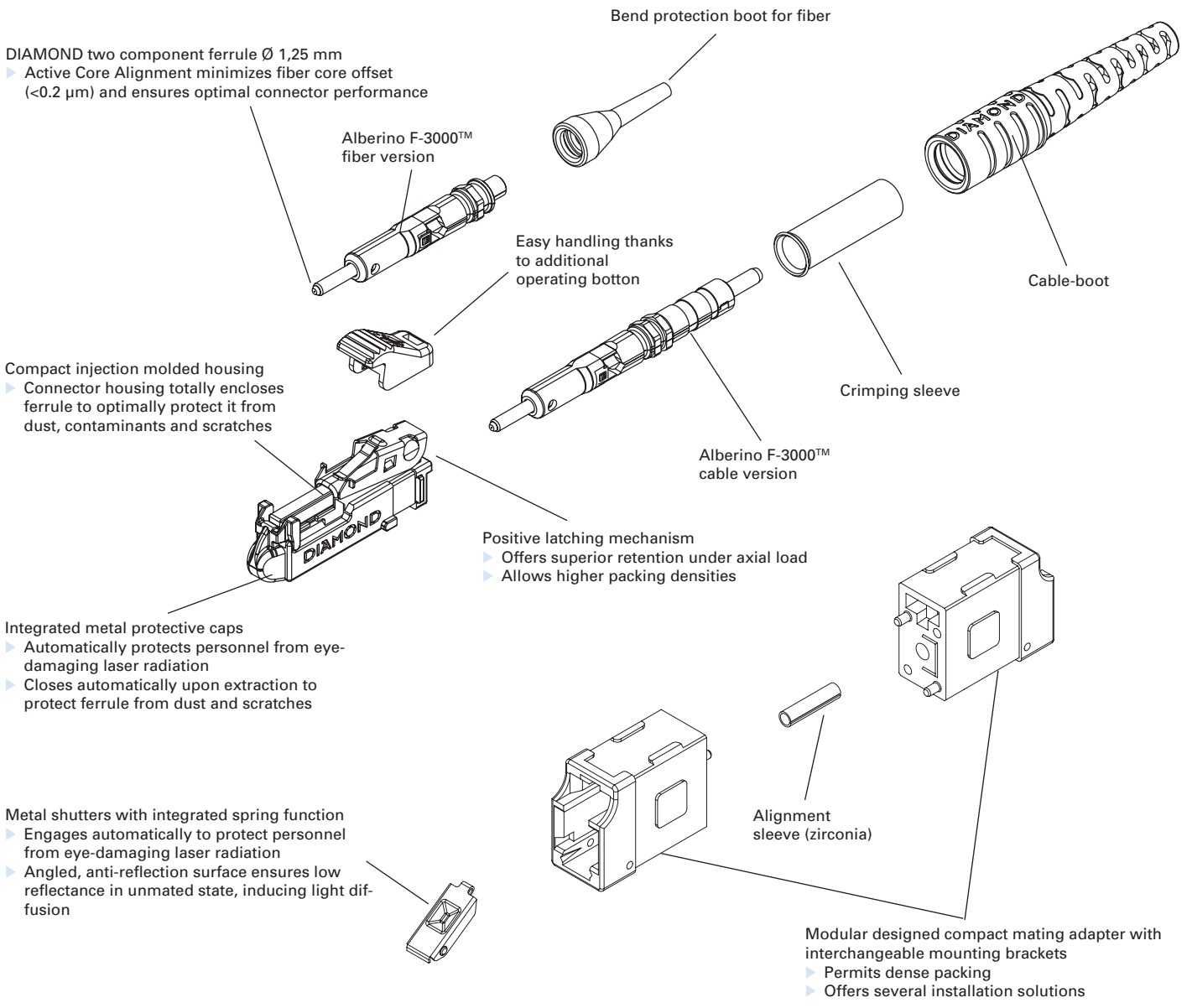

F-3000™ s version



The F-3000™ s without protection cap and button is a simplified version of the F-3000 standard connector.

F-3000™ LIFT version

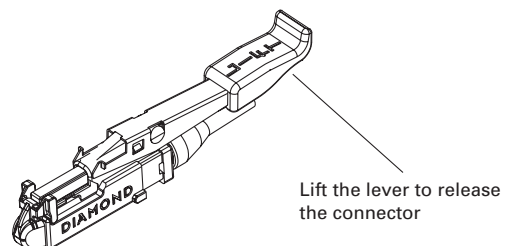
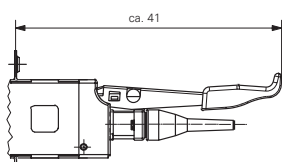

The ideal solution for special applications with difficult access.

THE F-3000™ DUPLEX

The F-3000™ DUPLEX combines the familiarity of the SFF design and the optical performances of the F-3000™ simplex connector. It is based on components of the F-3000™ simplex version and is joined by a simple clip-bridge and a widened thumb-latch. The F-3000™ DUPLEX is the ideal solution for applications such as Fiber-to-the X (FTTX), including FTTC, FTTH, FTTD.

AVAILABLE AS

- ▶ Standard terminated connector
- ▶ Connector set (to be terminated with Diamond special equipment)

F-3000™ Standard Duplex Adapter and connector

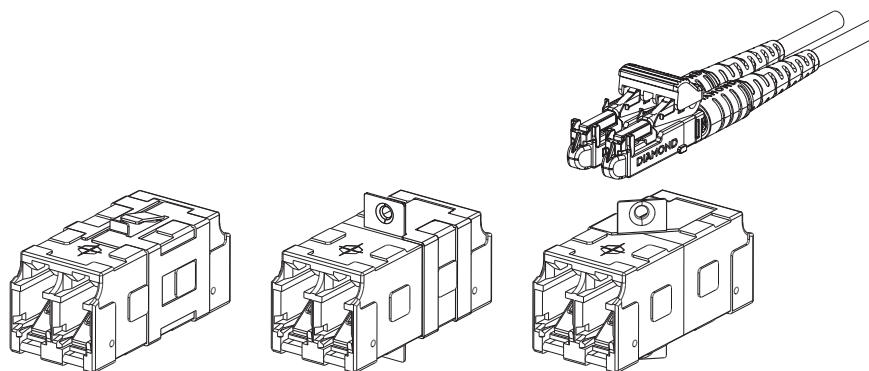

F-3000™ Junior Duplex Adapter and F-3000™ LIFT connector

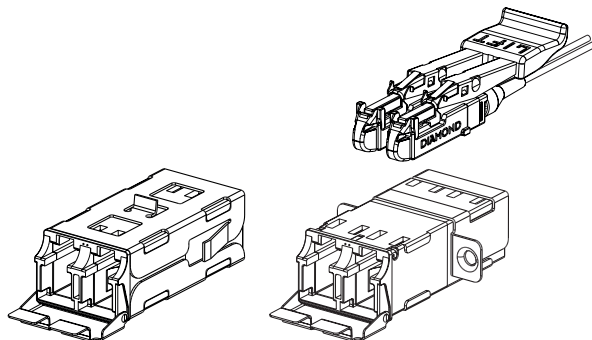

COLOR KEYING

The F-3000™ Junior system permits the user to specify the color of the mating adapter frame so that different line types, uses, destinations and points of origin, etc. can be readily identified.

The frame are available in twelve distinct colors:

- | | | |
|------------------|--------------------------|------------------------------|
| 1. Blue | 5. Orange (upon request) | 9. Grey |
| 2. Beige (White) | 6. Yellow | 10. Brown (upon request) |
| 3. Black | 7. Green | 11. Pink (upon request) |
| 4. Red | 8. Violet (upon request) | 12. Turquoise (upon request) |

NOTE As standard, Diamond uses colored connector bodies, cable boots and mating adapter housings to identify the fiber type (SM or MM 50/62.5µm) and ferrule polish (PC or APC).

Diamond's standard **connector/boot/adaptor** colors are as follows: Beige/Black/Beige for MM PC 50µm, Beige/Beige/Beige for MM PC 62.5µm, Blue/Blue/Blue for SM PC, and Green/Green/Green for SM APC. Other colors are available upon request.

THE F-3000™ BACKPLANE

The F-3000™ BACKPLANE combines the advantages of the F-3000™ SYSTEM with an optimal guiding mechanism for secure backplane connection. When mated, the PCB connector is retained in the mating adapter eliminating all stress on the PC Board.

It uses the standard components of the F-3000™ single fiber version which are joined by a simple clip-bridge that includes radial, angular and longitudinal compensation. Clip bridges are available for 2 and 4 connectors. The F-3000™ BACKPLANE is available in multimode, single mode, 0° (PC) and 8° angle polished (APC) versions. The F-3000™ Backplane offers the same optical performances as the F-3000™ simplex connector. The adapters can be easily mounted into the distribution panel.

The F-3000™ Backplane covers all needs in this field of applications and offers:

- ▶ Active push pull retention
- ▶ Sufficiently long pre-mating tracks for repeatable mating and high stability
- ▶ Injection moulded housing (UL 94 V0 flammability rating)
- ▶ Positive latching mechanism with step process to prevent the backplane and the PCB from stress
- ▶ Backplane adapter with spring loaded shutters and connectors with protective metal caps
- ▶ Longitudinal mating compensation
- ▶ Unique DIAMOND Ø 1.25 mm two component ferrule

AVAILABLE AS

- ▶ Standard terminated connector
- ▶ Connector set (to be terminated with Diamond special equipment)

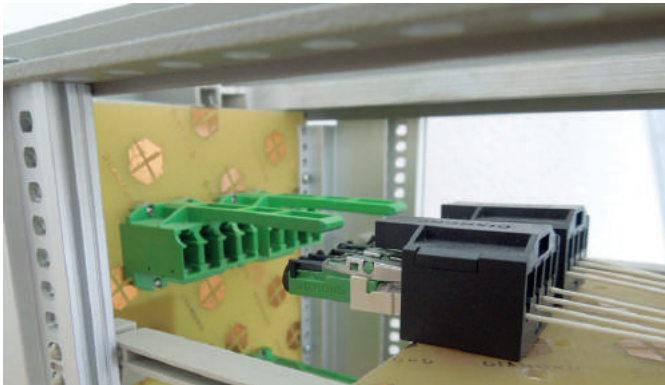

F-3000™ Backplane before mating

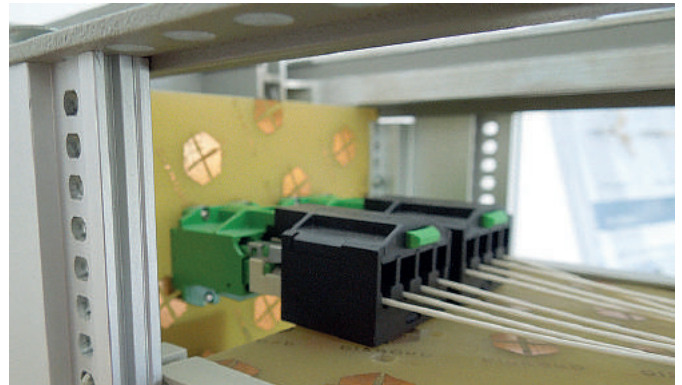

F-3000™ mated Backplane

THE F-3000™ r AND rs

Current installation techniques for Fiber Optics, either indoor or outdoor, tend to reduce installation times and expenses while keeping high quality standards.

Diamond's ferrule assembly for F-3000™ connectors is a compact pre-connectorized system which can be used in substitution to a standard Break-out cable within ducts of very small size or to be blown into microducts, offering an easy and reliable solution to perform FTTx installations.

After installation, the ferrule assembly can easily and rapidly be connectorized, avoiding time-consuming and expensive field termination tools and equipments.

This new Diamond ferrule assembly is available for Singlemode and Multimode fibers in PC 0° version. Typical applications include FTTx, Telecommunications Networks, CATV, Local Area Networks (LAN) and Data Processing Networks.



FEATURES AND BENEFITS

- ▶ Pre-terminated cable system
 - No need for field splicing and skilled installers**
- ▶ Factory manufacturing including measurement reports
 - Functioning Warranty and therefore no need for field measurement equipments**
- ▶ Ferrule assembly manufactured with Diamond Active Core Alignment
 - Superior optical performances**
- ▶ 1,25mm Ferrule assembly
 - Termination of SFF F-3000™r standard or F-3000™rs connectors suitable for the new generation of SFF and SFP components**



1.25mm Ferrule assembly
(Alberino F-3000™ r)

AVAILABLE AS

- ▶ Pre-connectorized ferrule assembly, to be terminated with Diamond special tools
- ▶ Typical assemblies are pigtails, patchcords on cable drums from 50 to 400 m

SPECIFICATIONS

	MULTIMODE 0° PC	SINGLE MODE 0° PC	UNITS	TEST CONDITIONS
Insertion Loss (IL)	typ. 0.25 max. 0.5		dB	IEC 61300-3-4; $\lambda = 1300\text{nm}$
Return Loss (RL)	min 40	min 50	dB	IEC 61300-3-6; $\lambda = 1300\text{nm}$
Repeatability of IL	max ± 0.15		dB	IEC 61300-2-2; $\lambda = 1300/1550\text{nm}$
Service life	min. 1000 mate/demate cycle		-	According to field experience
Operating temperature	-25/+70*		°C	

* May be further limited by cable specifications

NOTE As standard, Diamond uses colored connector bodies, cable boots and mating adapter housings to identify the fiber type (SM or MM 50/62.5 μm) and ferrule polish (PC or APC). F-3000™r **connector/boot** colors are as follows: Black/Black for MM PC 50 μm , Black/Beige for MM PC 62.5 μm , Black/Blue for SM PC. Other colors are available upon request.

THE F-3000™ POWER SOLUTION (PS)

Diamond F-3000™ PS connector is designed for high power applications up to 3 Watts optical power for SM fibers. This has been developed to support the continuous rise of higher bitrates and longer transmission distances within DWDM technology.

Diamond PS connectors are based on contacted expanded beam technology; where a section of graded index fiber is spliced as a collimating lens, which enlarges the beam diameter and reduces power density at the connector interface. Using Diamond Active Core Alignment (ACA) technology, we can achieve unrivaled low IL performances. This technology is applicable to most connectors interfaces, but due to safety issues Diamond suggests to use it on F-3000™ and E-2000™ connectors with integrated metal protection caps and shutters.

F-3000™ PS connectors are available as simplex terminated connectors and backplane 2-4 channels.

FEATURES AND BENEFITS

- ▶ 16x reduced power density
- ▶ Low Insertion loss and Ultra high polish for High return loss
- ▶ Integrated metal protection caps and Shutters

STANDARDS

- ▶ Passed Performance qualification according to *IEC 61753-2-1, cat. U*
- ▶ Passed Reliability qualification according to *IEC 62005-9-2, cat. U*
- ▶ Passed Long term Damp Heat according to *Telcordia GR-032685°C /85% r.h. 2000h*

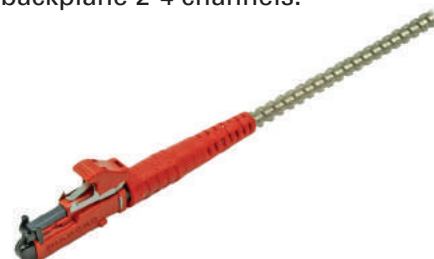

SPECIFICATIONS

CONNECTOR TYPE	WAVELENGTH (nm)	IL (dB) AGAINST REFERENCE		RL AGAINST REFERENCE		
		Typ.	Max.	Connected		Unmated
				PC 0°	APC 4°	APC 4°
F-3000™ PS	1625 - 1550 - 1310	0.2	0.4	45	75	50
	1060 - 980	0.3	0.6	35*	60*	
TEST CONDITIONS		IEC 61300-3-4		IEC 61300-3-6 OLCR method / *OCWR method		

* Measured with high precision reflectometer

SAFETY INFORMATION FOR POWER SOLUTION

Cleaning

Cleanliness still remains the key word using high power. The basic concept using PS connectors is therefore the following:

“before each mating procedure, the connectors must be absolutely clean and inspected with a microscope”.

The ferrule's surface inspection should be performed using an optical microscope with a magnification of at least 200x. The connector is normally affected by contamination during handling and mating procedures; the degree of cleanliness of the overall installation is also a critical parameter to be taken into consideration.

Handling

The Power Solution connectors should be operated with high power only when connected. When unmated, the light source must absolutely be switched off.

Safety

Optical connectors are passive components not subjected to Laser safety, but when integrated in an active system, as the output side of a light source, they will be submitted to it.

The following aspects are to be taken into account when evaluating the laser safety requirements:

- The exit beam of these connectors have a lower NA as standard connectors in air (NA=0.035) or ca. 2° divergence. This is used in the calculation of the amount of light that can enter the pupil at 1m.

The following safety precautions are to be considered as a starting point, each is responsible to edict proper safety protocols and we intend here just as to help doing this. The following precautions should not be considered as sufficient and should be reevaluated from case to case.

- usage in restricted area, access only for authorized and qualified personnel.
- use protective glasses, skin protective measures recommended.
- optical behavior under control: eliminate reflections (also diffuse), close unused optical channels, avoid light beams at eye level.
- switch on/off system with remote control or interlock and additional automatic switch off safety system.
- warning signal when sources are active.
- laser classification markings and danger indications.

THE F-3000™ FUSION

The F-3000™ FUSION allows you to quickly and easily make field terminations with the performance you expect from Diamond-quality F-3000™ connectors. The key to this system is DIAMOND's advanced "crocodile alberino" fusion field ferrule assembly. The ferrule assembly consists of a factory-terminated fiber endface, fiber stub, and integrated splice protection. The fiber endface is core-centered via Diamond's well-known Active Core Alignment process and factory-polished to the company's precise specifications. The F-3000™ FUSION is then field terminated via a low loss fusion splice using the new Diamond Zeus D50 Fusion Field Termination Kit. The F-3000™ FUSION is available for SM and MM fiber (250µm, 600µm and 900µm) and cable (1.6-to 3.1mm) in both 0° PC or 8° APC versions.



FEATURES AND BENEFITS

- ▶ Simple, fast and reliable field termination
reduces operator error and cost per termination
- ▶ No need of glue
- ▶ Outstanding optical performance
consistent and repeatable low IL / high RL
- ▶ No polishing
eliminates the need for costly consumables
- ▶ Fusion spliced pigtail performance and reliability without the cost and space associated with splice enclosures, trays and protectors

AVAILABLE AS

- ▶ Connector set, (to be terminated with Diamond special equipment)

COMPATIBLE SPLICERS WITH DIAMOND FUSION CROCODILE

- ▶ Fitel (Types: S132C, S153, S178)
- ▶ Sumitomo (Types: 71-C, T81C, Q101-CA)

SPECIFICATIONS

	MULTIMODE 0° PC	SINGLE MODE 0° PC	SINGLE MODE 8° APC	UNITS	TEST CONDITIONS
Insertion Loss (IL)	typ. 0.2 max 0.5	typ. 0.25 max. 0.5	typ 0.25 max. 0.5	dB	IEC 61300-3-4; λ = 1300/1550nm
Return Loss (RL)	min. 40	min. 50	min. 70*	dB	IEC 61300-3-6; λ = 1300/1550nm
Repeatability of IL	max. ±0.1			dB	IEC 61300-2-2; λ = 1300/1550nm
Service life	1000 mate/demate cycles				According to field experiences
Operating temperature	-25/+70**			°C	
Storage temperature	-25/+70**			°C	

* Measured with high precision reflectometer

** May be further limited by cable specifications



ZEUS D50 Fusion Splicer

F-3000™ FUSION INSTALLATION CONCEPT

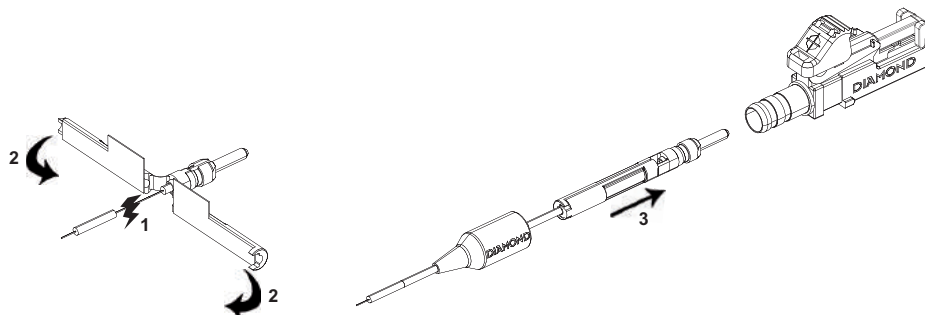

THE F-3000™ ACCESSORIES AND ACTIVE MODULES

The F-3000™ network accessories are available for many uses and can be deployed at several points in fiber-optic networks, as well as in LABs or special applications.

These include the following product families:

Attenuators (OAF), transition adapters (Sacrificial Interfaces and UGT), optical termination modules (OTM), hybrid-adapters, optical reflectors (OGR), multipurpose adapter system (MAS), Interfaces modules (IMOD), and active modules (SFP transceivers).

OAF F-3000™ ATTENUATORS

Attenuators are used to adapt the transmitted light power to the characteristics of the implanted receiver.

The OAF F-3000™ in-line fixed attenuator provide a precise and repeatable amount of light loss (attenuation) via a doped fiber. This results in wavelength independent and stable attenuation values for typical wavelength bands used in telecommunication applications (1260-1360 and 1460-1580 nm). OAF F-3000™ are available in single mode PC and APC version, for attenuations from 2 dB to 30 dB, for optical power up to +20 dBm.

Other available OAF types are: E-2000™, FC, SC, LSA (DIN) and ST™.

SPECIFICATIONS

	SINGLE MODE 0° PC					SINGLE MODE 8° APC					UNITS
Fiber	9/125										μm
Wavelengths	1260-1360 and 1460-1580										nm
Nominal attenuation	2	4	5	6	10	15	20	25	30		dB
Tolerance*	±0.5	±0.5	±0.5	±0.5	±1	±1.5	±2	±2.5	±2.5		dB
Repeatability	<0.5 over service life										dB
Service life	1000 matings (According to field experience)										
Return loss	>45					>65					dB
Temperature range	-25/+70										°C

* Values measured using 1310 or 1550 nm LED source. Additional IL induced by modal noise 0,05 dB/dB.
The excess attenuation due to the 2 connections may be as high as 0.5 dB max.

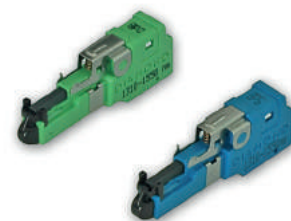

F-3000™ SI and UGT (Optical Transition Adapters)

Optical Sacrificial Interfaces are compact, in-line, male-to-female components, especially used in laboratory and field test equipment to protect front panel connector end-faces from the damage and contamination of repeated mating and de-mating. The use of sacrificial interfaces avoids costly instrument re-calibration that usually requires the equipment to be returned to the manufacturer or specialized service centers and eliminates equipment down time. Diamond Sacrificial Interfaces are available for MM and SM fibers, with different end-face geometries: PC/PC, APC/APC, to a wide range of international connector standards. UGTs Optical Transition Adapters (male/female) are also space saving in-line components, mainly deployed to connect different connector geometries, (eg. from 0° PC connectors to 8° angle-polished APC connector or the reverse).

Other available types are: E-2000™, FC, SC, ST™ and DiaLink.

SPECIFICATIONS

	SM G. 652D	MM	UNITS	TEST CONDITIONS
Insertion Loss (IL)*	max 0.7 dB	max 0.7 dB	dB	IEC 61300-3-4; λ = 1300/1550nm SM - 850/1300nm MM
Return Loss (RL)	PC min 45 / APC min 70**	min 35 dB	dB	IEC 61300-3-6; λ = 1300/1550nm SM - 850/1300nm MM
Repeatability of IL	max ±0.3		dB	IEC 61300-2-2; λ = 1300/1550nm SM - 850/1300nm MM
Service life	500 mate/demate cycles			
Operating temperature	-40/+85		°C	
Storage temperature	-40/+90		°C	

* Total Insertion Loss. Additional IL due to modal noise max 0.5 dB

** Measured with high resolution reflectometer HP

Other fibers available upon request



F-3000™ OTM (Optical Termination Modules)

F-3000™ OTM Optical Termination Modules are used as fiber termination on open, unused channels in telecommunication distribution panels, measuring devices and CATV installations, in order to have a stable and lower back reflection in the system. Other available OTM types are: E-2000™, FC, and SC.

SPECIFICATIONS

	SINGLE MODE 0° PC	SINGLE MODE 8° APC	UNITS	TEST CONDITIONS
Insertion Loss (IL)	NA		-	
Return Loss (RL)	min 45	min 70*	dB	IEC 61300-3-6; $\lambda = 1300/1550\text{nm}$
Service life	500 mate/demate cycles			
Operating temperature	-40/+85		°C	
Storage temperature	-40/+90		°C	

* Measured with high precision reflectometer



F-3000™ HYBRID ADAPTERS

F-3000™ hybrid adapters ensure a connection between a F-3000™ and SC/FC/LSA (DIN) fiber optic connectors. Their optical performance and compact size make is a logical and cost-effective alternative to hybrid patch assemblies.

SPECIFICATIONS

	MULTIMODE 0° PC	SINGLE MODE 0° PC	SINGLE MODE 8° APC	UNITS	TEST CONDITIONS
Insertion Loss (IL)*	typ. 0.15	typ. 0.2	typ. 0.2	dB	IEC 61300-3-4; $\lambda = 1300/1550\text{nm}$
Repeatability of IL	max ± 0.1			dB	IEC 61300-2-2; $\lambda = 1300/1550\text{nm}$
Service life	1000 mate/demate cycles				According to field experience
Operating temperature	-40/+85			°C	
Storage temperature	-40/+90			°C	

* IL measured using two reference cables

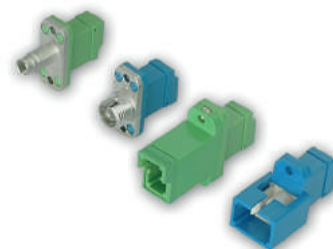

NOTE Optical and mechanical specifications are based on the use of the connector of corresponding standard; the above table reflects typical values.

F-3000™ OGR (Optical Reflectors)

F-3000™ OGR are normally used as fiber termination with the highest possible back reflection. They are mainly deployed in device manufacturing or LABs for calibration purposes, or for measuring back reflection within fiber-optic components. They are also used to provide reference reflection levels by measuring the sensitivity of sources to back reflection from other devices. Other available OGR types are: E-2000™, FC, SC and ST™.

SPECIFICATIONS

	SINGLE MODE PC/APC	UNITS	TEST CONDITIONS
Return Loss (Including connector loss)	Typ. 0.5	dB	IEC 61300-3-6; $\lambda = 1310/1550\text{nm}$
Polarization dependence of return loss	Typ. 0.2 max. 0.3	dB	IEC 61300-3-2; $\lambda = 1550\text{nm}$
Wavelength dependence of return loss	Typ. 0.5 max. 0.8	dB	IEC 61300-3-7; $\lambda = \text{from } 1280 \text{ to } 1580\text{nm}$
Repeatability of RL	max +/- 0.1	dB	IEC 61300-3-6; $\lambda = 1310/1550\text{nm}$
Service life	500 mate/demate		IEC 61300-2-2
Operating temperature	-25 / +70	°C	IEC 61300-2-22
Storage temperature	-40 / +85	°C	



F-3000™ MAS (Multipurpose Adapter System)

The F-3000™ MAS is a modular interchangeable adapter system whose size, ease of cleaning and inspection, and optical performance make it an ideal choice for high performance applications such as test and measurement equipment.

This system is composed of a flange which provides an internal connection via a FC or Mini-AVIM style connector and a wide range of interchangeable adapters including the F-3000™, E-2000™, FC, SC, ST™ and LSA (DIN).

SPECIFICATIONS

	MULTIMODE 0° PC	SINGLE MODE 0° PC	SINGLE MODE 8° APC	UNITS	TEST CONDITIONS
Insertion Loss (IL)*		max 0.25		dB	IEC 61300-3-4; $\lambda = 1300/1550\text{nm}$
Repeatability of IL*		max ± 0.15		dB	IEC 61300-2-2; $\lambda = 1300/1550\text{nm}$
Service life (adapters)		500 mating cycles			
Service life (connectors)		1000 mating cycles			
Operating temperature		-25/+70		°C	

* Measured using two reference connectors. Valid for ferrule type 2.5 mm diameter. For other types, please contact your local DIAMOND representative

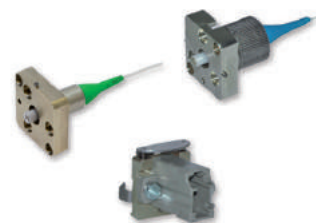

F-3000™ IMOD (Interfaces Modules)

The F-3000™ Interface Module (IMOD) has been developed as a half adapter for free space application of optical connector. These modules are used more commonly for PC 0° connection, but version for using APC 8° ferrules can be offered as custom component. The two major reasons for using a high quality IMOD are the need of repeatable positioning in both axial and radial direction between each connector and each IMOD.

Other available IMOD types are: E-2000™, FC, SC, ST™, LSA (DIN), Mini-AVIM.



SFP MODULES (Transceivers)

The DIAMOND SFP modules (transceivers) allow direct connection (plug and play) to active components, such as switches, converters, routers etc. which have SFP ports with a transmission speed of 100Mbit/s respectively 1 Gbits, according to standard IEEE802.3. The main advantage of these transceivers is the flexibility with which they can be used, according to the application field.

Features of the duplex SFPs:

- ▶ Compatible with F-3000™ and LC connectors styles
- ▶ Transmission speed of 100Mbit/s respectively 1 Gbits
- ▶ Singlemode or Multimode versions
- ▶ Hot swappable

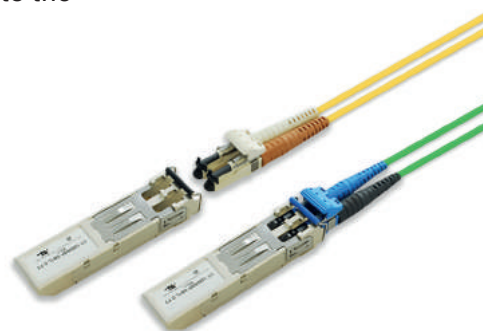

Features of the simplex Bidi SFPs:

- ▶ Compatible with F-3000s and LC connector types
- ▶ Bi-directional Fiber SFP modules
- ▶ Transmission speed of 1 Gbit
- ▶ 3km on 9/125micron single-mode fiber
- ▶ Tx=1310nm Rx=1490nm / Tx=1490nm Rx=1310nm
- ▶ Hot swappable



DIAMOND TECHNOLOGIES

POWER SOLUTION OPTICAL INTERFACES FOR F-3000™ CONNECTORS

Diamond uses different methods for expanded beam alignment, depending on the final use of the assembly. The main expanded beam types can be defined as the following: spliced GRIN lenses and spliced glass rod, or endcap which provides a Diverging, Collimated or Focused exit beam. These optical interfaces are also suitable for high power applications.

PS Collimated (Contact)

Diamond offers the Power Solution optical Interface which expands the MFD of a SM fiber by splicing a GRIN lens at the extremity. The MFD at the end of the connector is thus expanded by a factor of 4 to 5, increasing the contact surface by a factor of about 15. As a result the heat issues decrease but cleanliness of the connectors and mating adapters is still important.

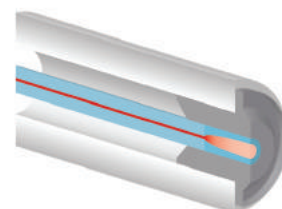

PM-PS Collimated Polarization Maintaining (Contact)

Polarization plays an important role in the industrial photonics market and when coupled with medium-high power application, creates a highly critical interface. Sensors and communication systems have been designed using Polarization Maintaining or Polarizing fibers. Special connectors are required for such applications, because the connection must be made with a certain orientation. Only connectors with an orientation key are capable of properly terminating these fibers.

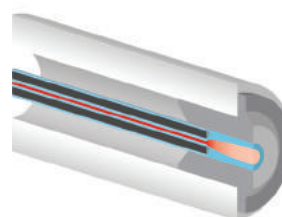

PSm Power Solution Multimode (Contact)

No standards for large MM connectors has been defined with high power application in mind. The quality of the contact is critical and the standard SM fiber optical interface is not sufficient. Diamond has established a new Optical Interface, the PSm, to fill this void and help end-users to source reliable connectors for these applications.

The optical interfaces use 100% concentricity measurement control and optical geometry measurements. A special visual inspection completes the Optical Interface definition.

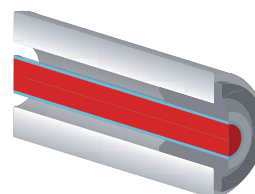

PSf Free Space (Diverging, non contact)

A glass rod is spliced at the end of a SM fiber. This allows the beam to be expanded before it exits the glass, diminishing the power density at the glass-air interface. This technique is used for high-power applications, at the injection or at the output to minimize the chance of burns at the interface. Diamond provides the SM Power Solution Freespace Optical Interface using this technology.

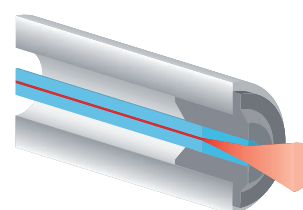

PSi Free Standing

The fiber-end free from epoxy glue allows proper thermal dissipation in the region of maximum power density.

A proprietary design of mode-stripper can be integrated to obtain laser power confinement in the fiber core. The amount of power stripped out from the cladding is a function of the laser Beam Product Parameter (BPP) and of the receiving fiber core diameter and numerical aperture (NA).

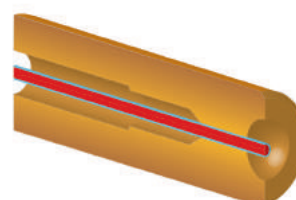

PSc Collimator Systems

Collimators are for use in a wide variety of optical systems.

These modules are designed to collimate or focus light exiting an optical fiber to a desired beam diameter or spot size a specific distance away. Collimators are used with laser diodes, photodiodes, acoustic-optic modulators and other fiber optic devices where a specific output is needed.

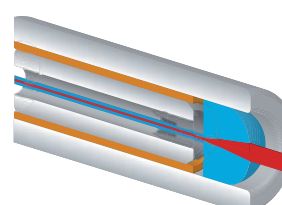

VIS/NIR LOW WAVELENGTHS

Diamond offers the VIS/NIR optical interface for low wavelengths and small core fibers on F-3000™ connectors based on the Active Core Alignment (ACA) technology aiming to achieve unrivaled low IL performances.

Advantages

- ▶ Extremely low lateral offset for low insertion loss
- ▶ Ultra high polish for high return loss

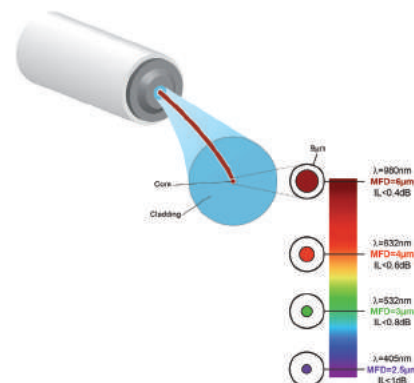

OPTICAL LINE IDENTIFICATION (OLiD)

DIAMOND has developed a new network monitoring system which is based on Fiber Bragg Grating (FBG) technology. In a P2P network installation, this technology is used to identify each fiber line and manage the Optical Line Identification OLiD information through a data base owned by the network operator.

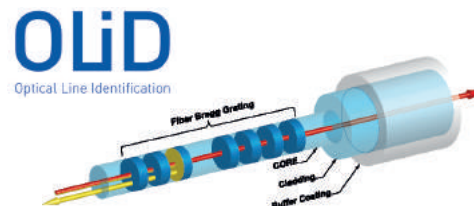

Available products

- ▶ F-3000™ OLiD assemblies, UGT, Outlets

POLARIZATION MAINTAINING (PM)

DIAMOND supplies high-quality solutions to polarization maintaining (PM) and polarizing (PZ) fiber optical interfaces for optimal control of the signal’s polarization state. Low insertion losses (IL) combined with high polarization extinction ratios (PER) and higher return losses (RL) are achieved over very broad spectral ranges thanks to a combination of accurate optical and mechanical design.

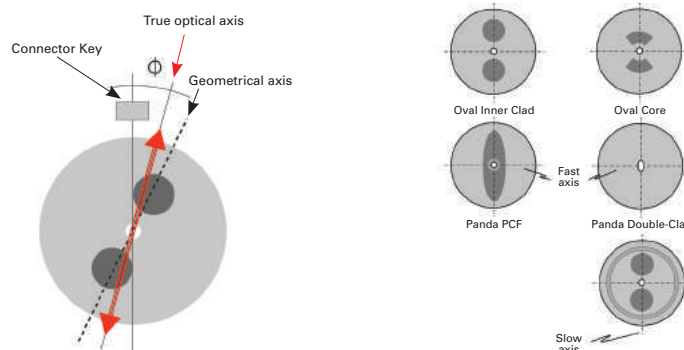

STANDARD PERFORMANCES

WAVELENGTH (nm)	Angular Error ϕ	IL (dB)		PER (dB)		RL (dB)	
		Typ	97% (TBC)	Typ	Min (TBC)	PC 0°	APC 8°
1625 - 1550 - 1310	< $\pm 2^\circ$	0.15	0.30	30	27	50*	70*
1060 - 980		0.20	0.40	30	26	50	60*
830 - 780		0.25	0.50	28	25	40	60**
680 - 635		0.30	0.60	28	25	40	60**
532 - 460		0.40	0.80	27	24	35	60**
405		0.75	1.20	23	21	35	60**
TEST CONDITIONS		IEC 61300-3-34 Random mating		IEC 61300-3-40 Low coherence		IEC 61300-3-6 *OLCR method <OCWR method **Limited by test conditions	
Lifetime	500 mate/demate cycles						

NOTE - Optical values based upon high-quality Panda and Bow-Tie fibers qualified by Diamond (fiber’s NA 0.12± 0.02).
 - Performances based upon E-2000™ optical interfaces; other mechanical interfaces may lead to slightly different results. Please contact Diamond for details.
 - Diamond performs PER measurements according to the crossed-polarizer method (similar to IEC 61300-3-40) that relies upon high-extinction Glan-Thomson polarizers and incoherent light sources (bandwidth > 10 nm).
 - For any other requirement, please contact Diamond.

DRAWINGS AND DIMENSIONS

F-3000™ SIMPLEX CONNECTOR

F-3000™ Simplex connectors 900 µm - 3 mm boot style

Ferrule material: Zirconia/metal insert
 External parts: Plastic

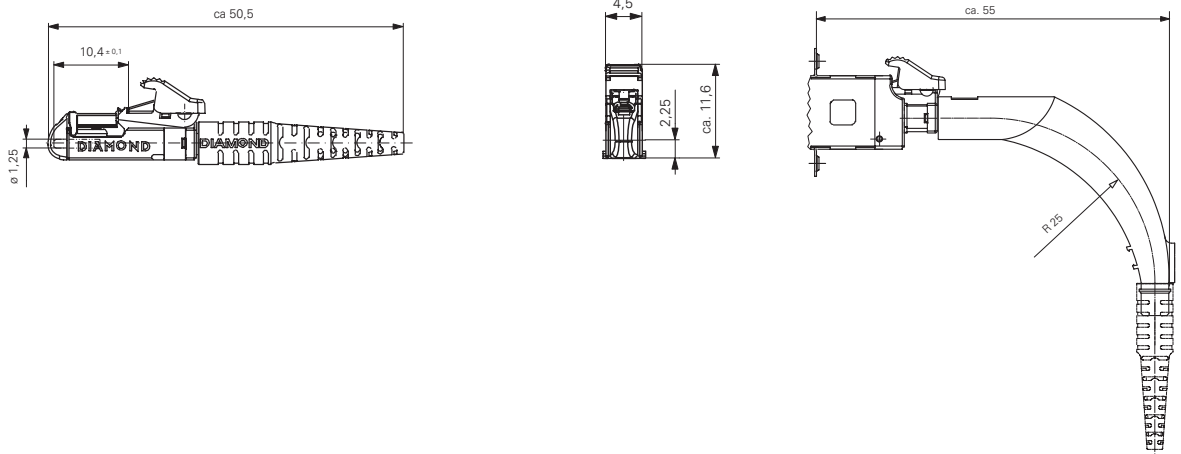

F-3000™ s Simplex connectors 900 µm - 3 mm boot style



OPTION: LONG THUMB-LATCH

The ideal solution for special applications with difficult access

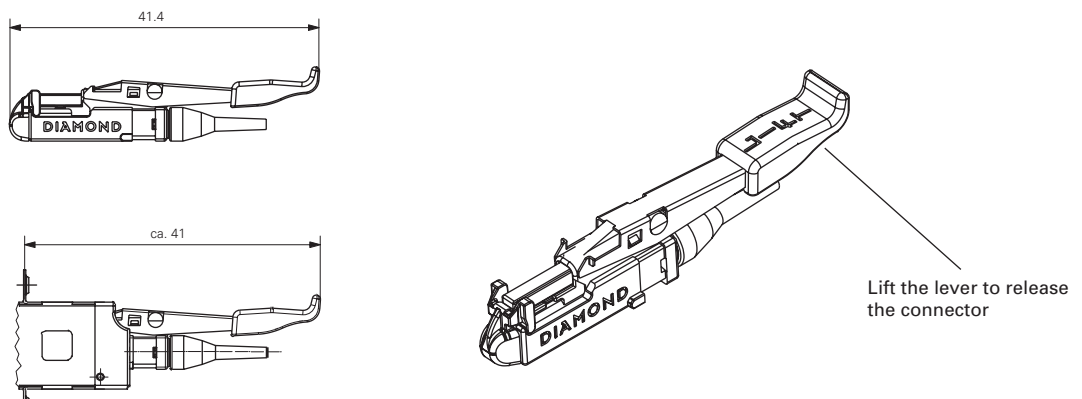

NOTES: - Please contact your local Diamond representative for additional information

F-3000™ SIMPLEX ADAPTERS

F-3000™ Simplex mating adapter with screw fixing clip

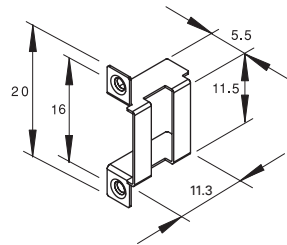
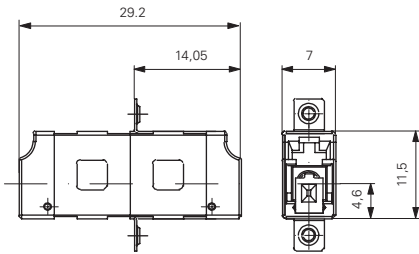

CUTOUT DIMENSIONS

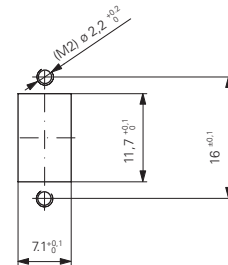

F-3000™ Simplex mating adapter with quick fixing clip

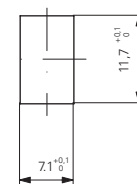
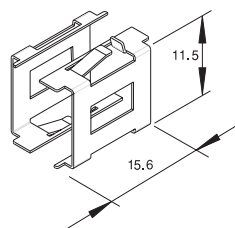
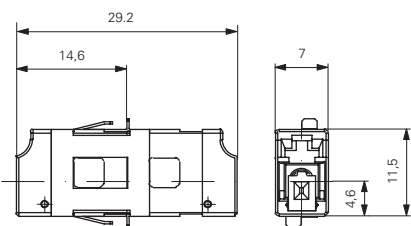

Max wall thickness 1.6 mm

F-3000™ DUPLEX CONNECTOR

F-3000™ Duplex connectors 900 μm - 3 mm boot style

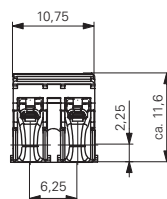
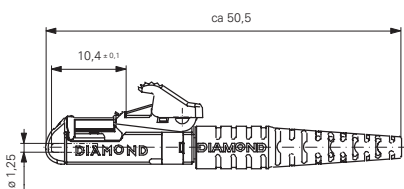

F-3000™ DUPLEX ADAPTERS

F-3000™ Duplex mating adapter with screw fixing clip

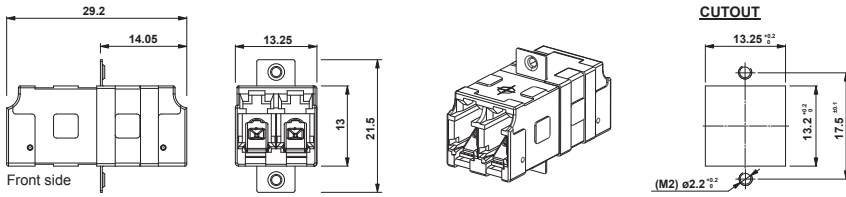

F-3000™ Duplex mating adapter with quick fixing clips

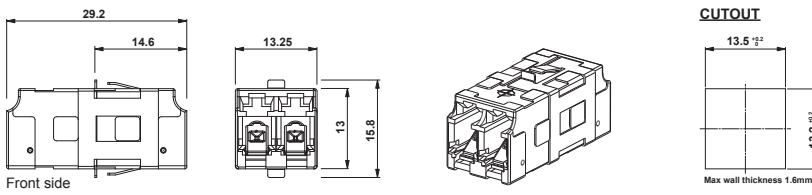

F-3000™ Duplex mating adapter with 45° screw fixing clip

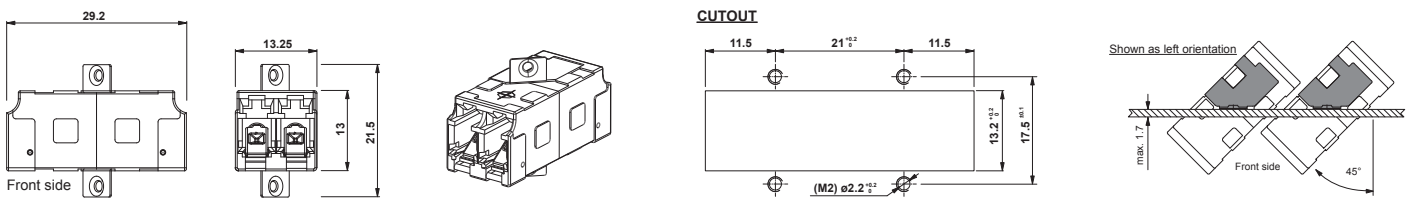

F-3000™ Junior mating adapter with quick fixing clip (Typ B: for excellent stability within SC cutout)

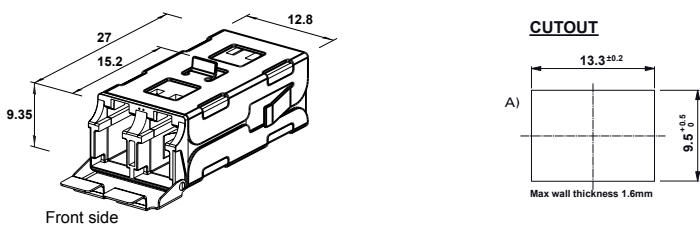

F-3000™ Junior mating adapter with screw fixing clip

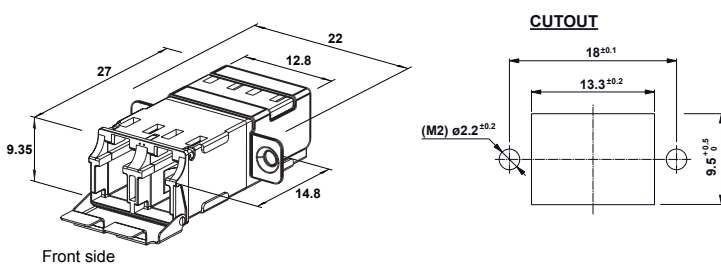

F-3000™ BACKPLANE CONNECTOR AND ADAPTERS

F-3000™ Backplane connectors on 900 µm fiber, without boot

Ferrule material: Zirconia/copper-nickel alloy insert
 External parts: Plastic

NOTE Standard connector colors are: MM 50µm; and MM 62.5µm (beige);
 SM PC (blue); SM APC (green).

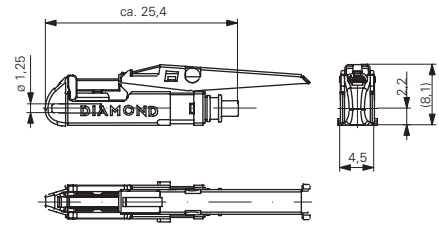

F-3000™ PCB adapters, 2 and 6 channels

Material: PBT (black)

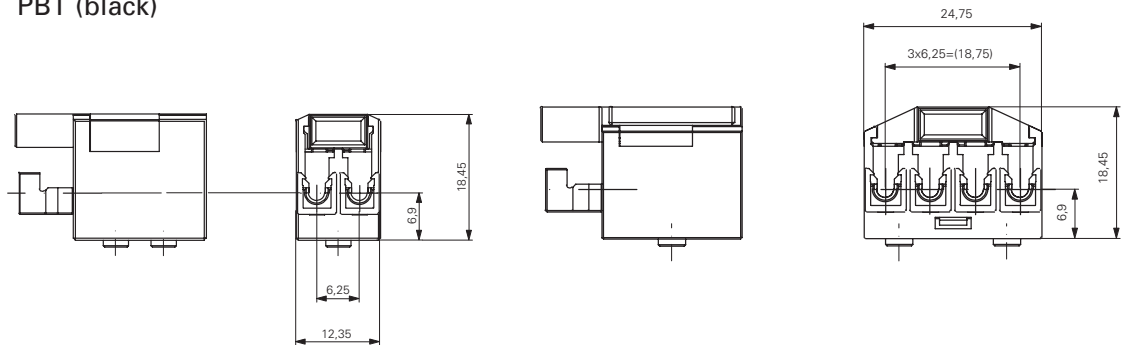

F-3000™ Backplane adapters, 2 and 4 channels

Material: Plastic
 Mating sleeve: Zirconia

NOTE Standard colors are: MM PC (beige); SM PC (blue); SM APC (green).

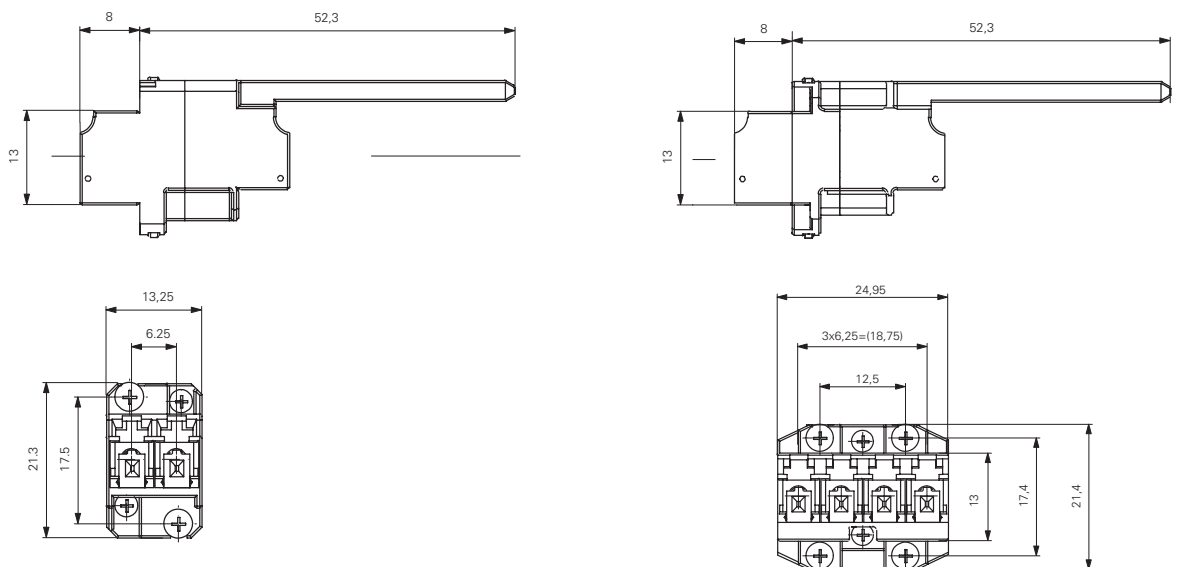

CUTOUT DIMENSIONS

4 channel unit

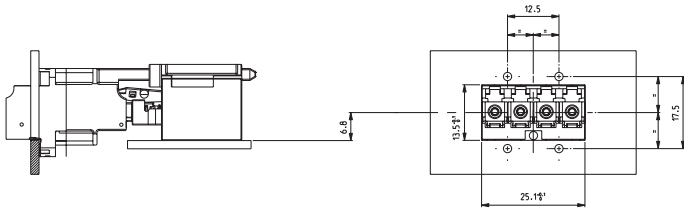

2 channel unit

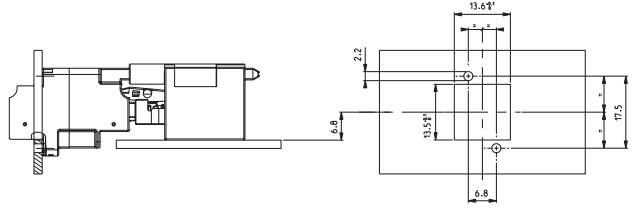

MODULAR MOUNTING

4 channel unit

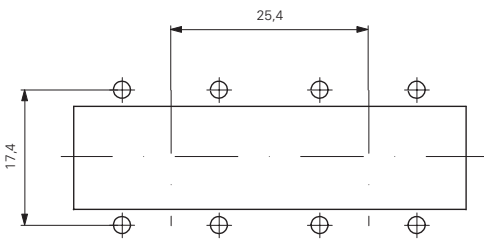

2 channel unit

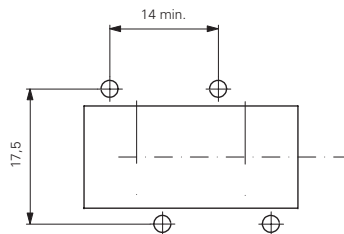

4 channel - 2 channel unit combined

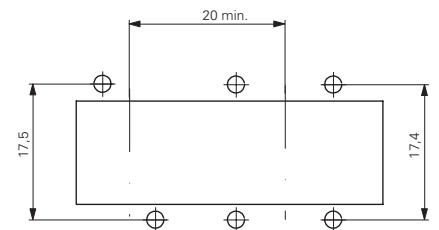

APPLICATION NOTES

Fiber optic connectors for backplane also require the pre-mating of all involved components, to prevent lateral forces, while mated. For repeatable and secure pre-mating and mating procedures, the F-3000™ BACKPLANE has a high adaptation degree of the connectors on the PC Board to the backplane mating adapter. The system is designed to recover lateral misalignment up to ±0.5 mm.

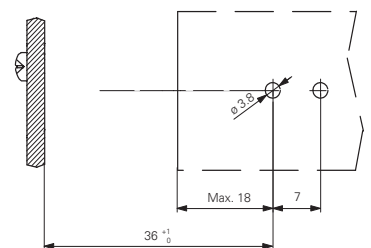
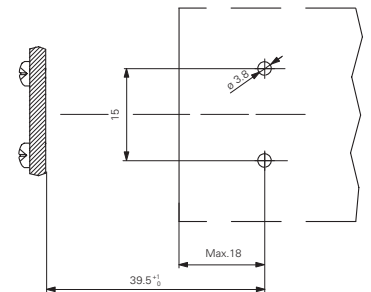
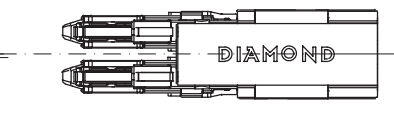
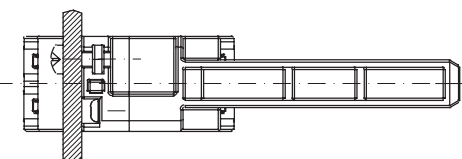
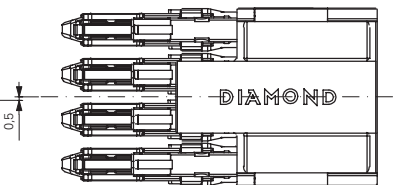
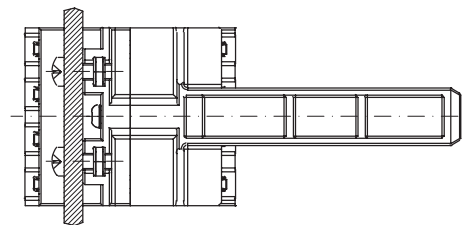
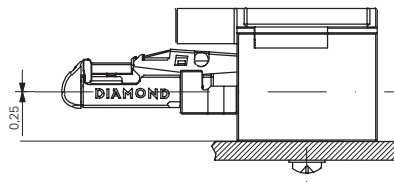
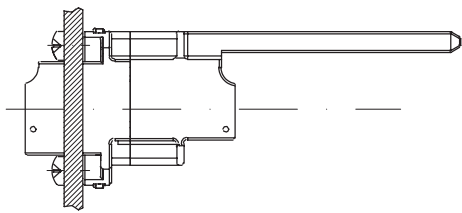

PROPOSED SPACE REQUIREMENT AND CONTROL ZONE

The F-3000™ BACKPLANE mechanism guarantees secure retention and eliminates stress at the PC Board when mated. After completion of the mating procedure the system allows a longitudinal way compensation.

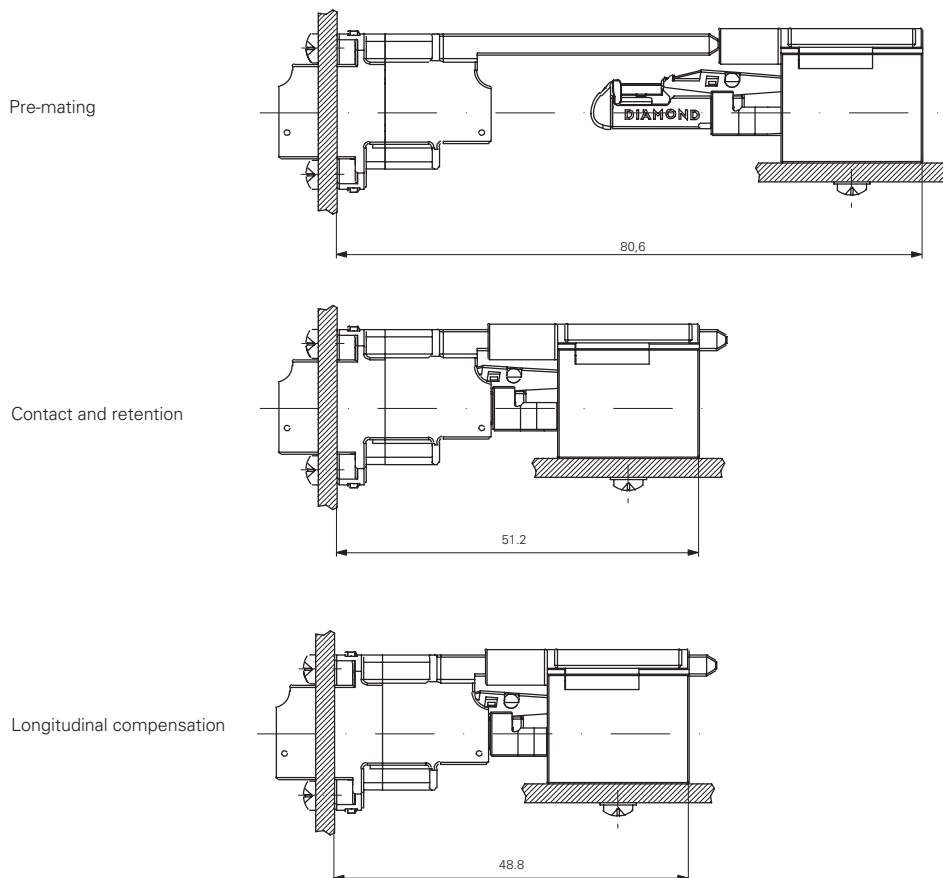

OAF F-3000™

Ferrule type: Standard $\varnothing 1.25$ mm Zirconia/Cu-Ni alloy
 Alignment sleeve: Zirconia
 External parts: Standard blue plastic housing for PC, and green for APC version.

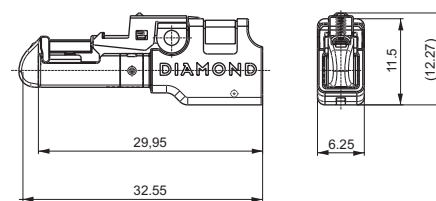

SACRIFICIAL INTERFACE / UGT F-3000™

External parts: Black plastic for SM with marking for PC and APC side; Beige plastic for MM

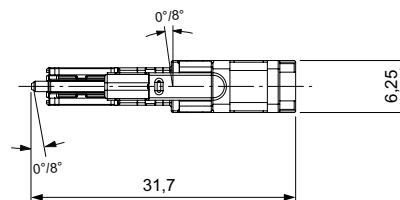

OTM F-3000™

Standard blue plastic housing and latch for PC and green for APC ($\varnothing 1.25$ mm Ferrule).

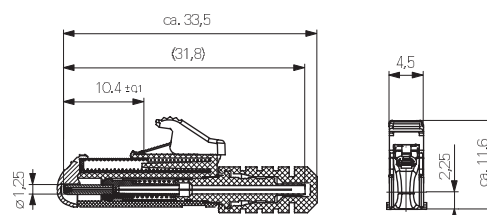

F-3000™ HYBRID ADAPTERS

HYB. F-3000™/LSA (DIN)

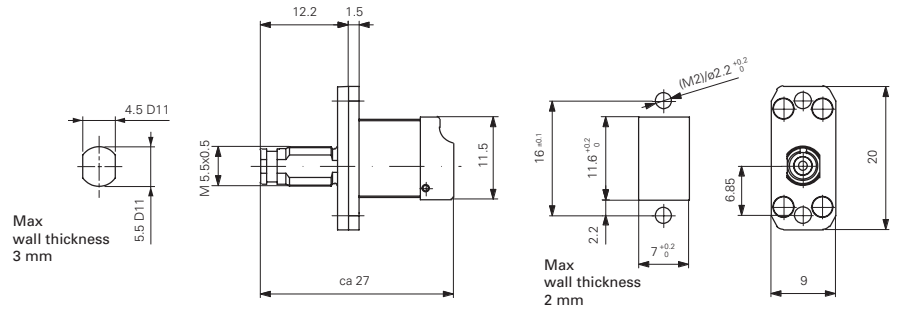

HYB. F-3000™/FC

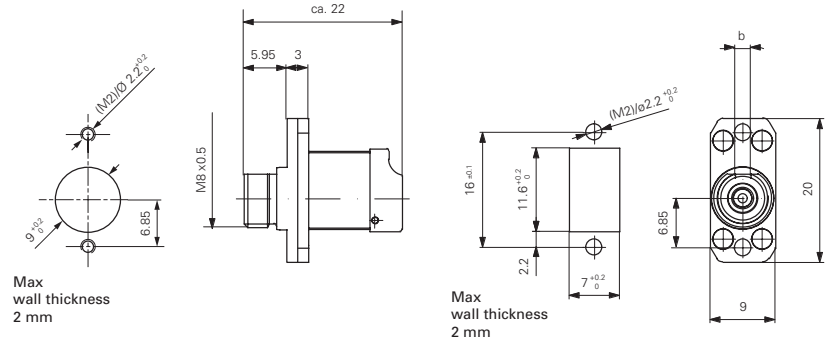

HYB. F-3000™/SC

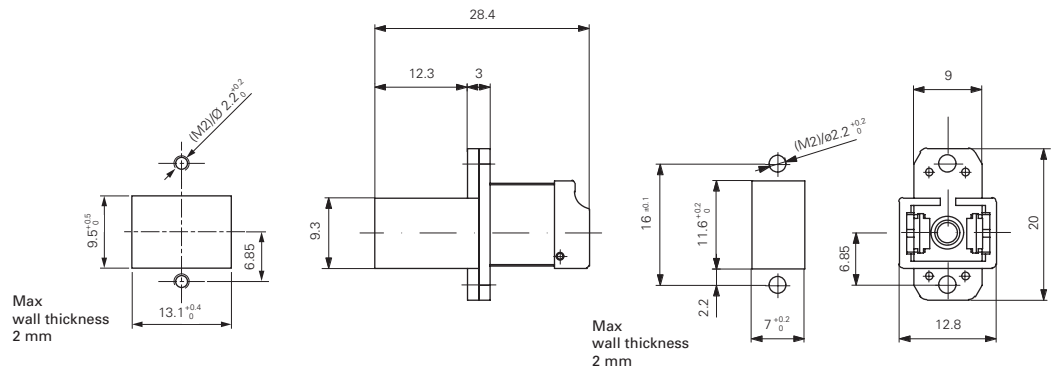

HYB. F-3000™/E-2000™

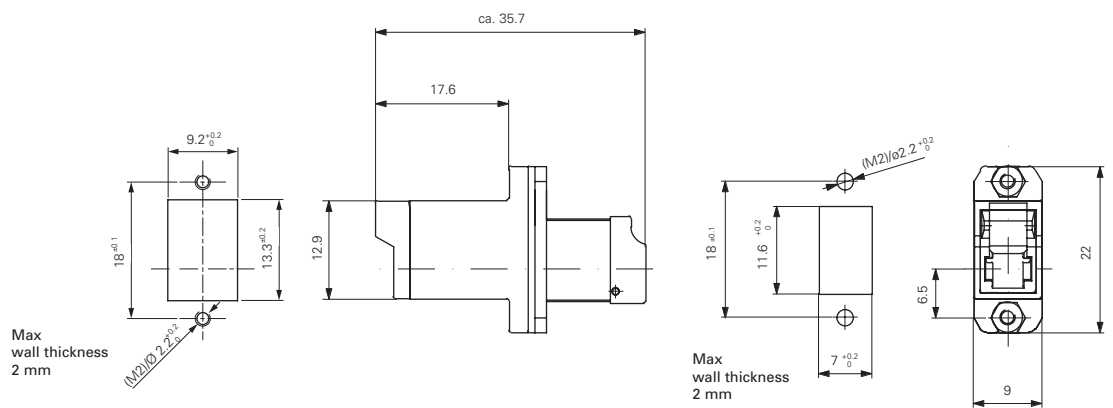

OGR F-3000™ (LC)

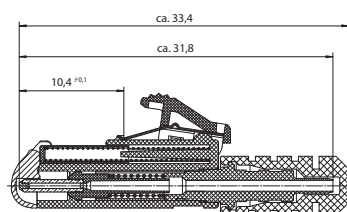

F-3000™ MAS (MULTIPURPOSE ADAPTER SYSTEM)

MAS Universal flange (FC interface)

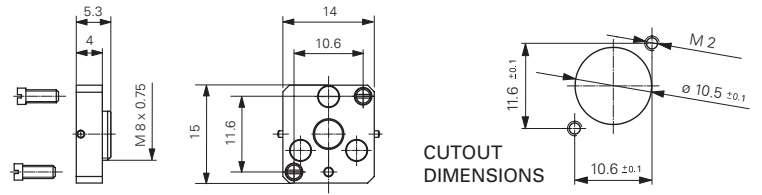

MAS Universal flange (Mini-AVIM interface)

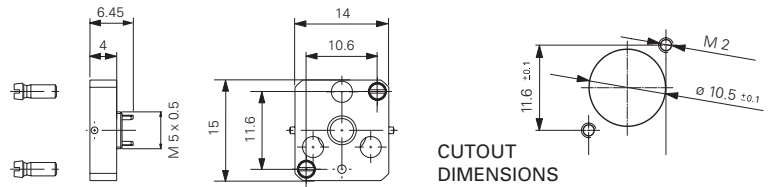

MAS F-3000™

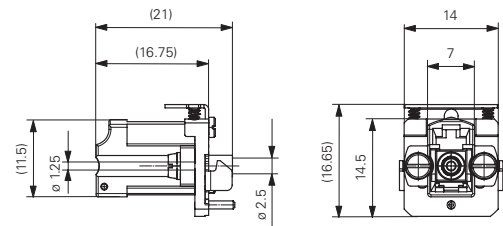

F-3000™ IMOD (INTERFACE MODULE)

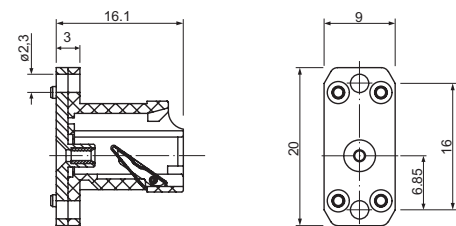

ORDER INFORMATION

Please contact your nearest local Diamond representative or visit www.diamond-fo.com website.